

Shift

Foster + Partners
.11

Shift



INTRO

The Shift collection, another collaboration between Tecno and the Foster+Partners design studio, is a new, formal, managerial and private furniture solution. The collection's sleek, flowing lines make it the perfect complement to work and domestic environments.

The Shift collection is made up of three elements: a table, a bookcase and a cabinet. The table-desk (240 x 95 cm, h 75 cm) is the element that best symbolises the collection. With its simple, oval shape, it is clearly designed for versatility. Electrical cables are routed through cable ducts inside the slender legs. The table top is available in a choice of two materials and finishes: 25 mm thick MDF panels with a matt or gloss white lacquer finish or 25 mm thick MDF panels veneered in light oak and finished in clear acrylic varnish. The top features elegant rounded edges and even the underside is finished in matt white lacquer. The bases are in Cristalplant® and are also finished in matt white.

The Shift cabinet (190 x 53 cm, h 59 cm) is characterised by clean lines and shares the same powerful, expressive volumes and shapes as the table. The cabinet is available in four versions: 2 large drawers, 4 standard drawers, 2 standard drawers and 1 large drawer on the left, and 2 standard drawers and 1 large drawer on the right. All versions are lockable. Cabinet tops come in three different finishes: matt white lacquer, gloss white lacquer and light oak. The body and frame have a standard matt white lacquer finish.

The Shift bookcase (240 x 45 cm, h 99/139 cm) reflects the slender, rounded forms of the table and comes in two versions with 3 or 4 shelves. The bookcase structure is in aluminium with a matt white paint finish.

DESIGNER

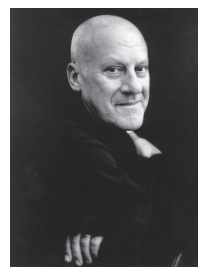

Norman Foster

Shift

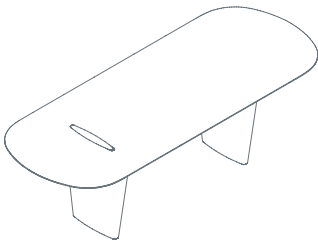
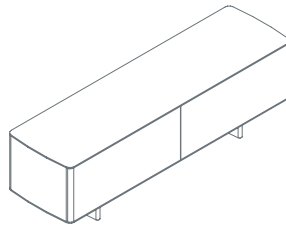
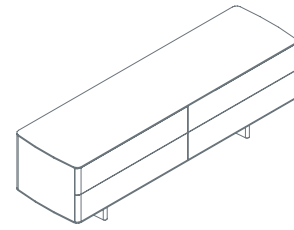

Table with grommet
1SH4020: L 94½ D 37½ H 29½



Storage lockable unit with 2 filing draws
1SH5010: L 74¾ D 21 H 23¼



Storage lockable unit with 4 drawers
1SH5020: L 74¾ D 21 H 23¼

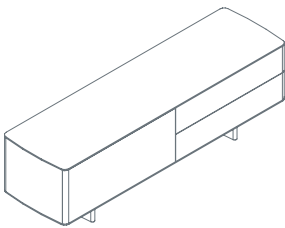

Storage lockable unit, 1 left filing drawer
and 2 right drawers
1SH5030: L 74¾ D 21 H 23¼

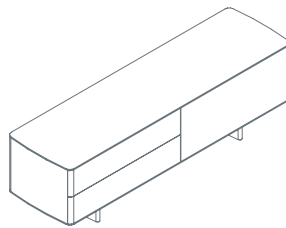

Storage lockable unit, 2 left drawers
and 1 right filing drawer
1SH5040: L 74¾ D 21 H 23¼

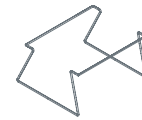

Hanging files frame for filing drawers
1SH3031

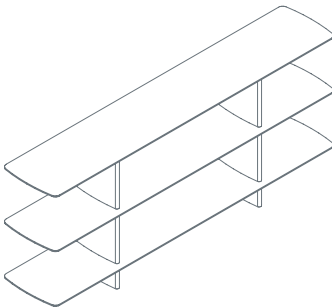

3 shelves bookshelf
1SH5100: L 94½ D 17¾ H 23¼

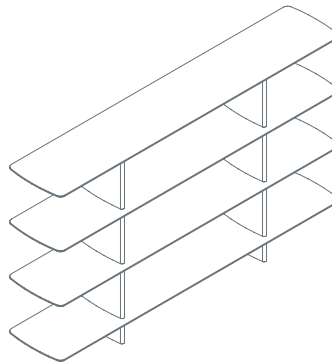

4 shelves bookshelf
1SH5110: L 94½ D 17¾ H 54¾